

JMS Liners Measurement Form

Quote# _____

For Custom In-Ground Pool Liners

Date _____

JMS Liners

27 Margaret Drive

Broad Brook, CT 06016

Phone/Fax:

860-623-9291

Pool Owner Name _____

Address _____

City _____ St _____ Zip _____

Phone _____ Fax _____

E-Mail Address _____

Your Signature _____

Your signature indicates that you have verified your measurements and that the information you have provided is correct. Your new vinyl liner will be made to these specifications once you place your order. (Orders cannot be processed without your signature)

1 LINER PATTERN

Pattern Name: _____

Mil (check one): 20mil 28mil

2 CORNER TYPE

Check your corner type below & enter measurements where required:

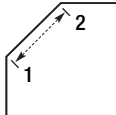
Cut Corner  Point 1 to Point 2: _____

90 Degree Corner  No measurements required for square corners.

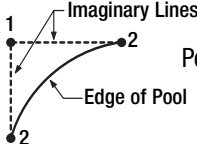
Radius/Rounded Corner  Point 1 to Point 2: _____

3 LINER TYPE

Beaded

Low Hung Beaded

Overlap
How many inches of liner do you need for the overlap? _____

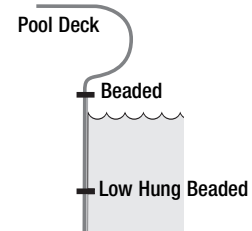

If you selected "Beaded" or "Low Hung Beaded," please also indicate below if your liner is a **Standard** or **Reverse** bead:

Standard Bead

Reverse Bead

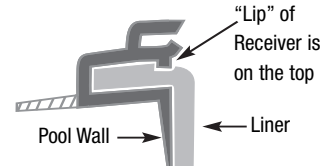
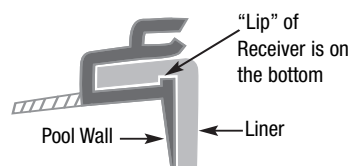

4 HOPPER TYPE

Check one & fill in measurements on the form to the right:

A. Standard Hopper

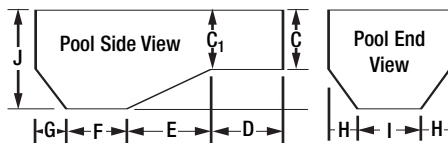

B. Wedge Hopper

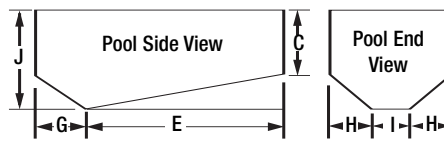

C. Constant Slope Hopper

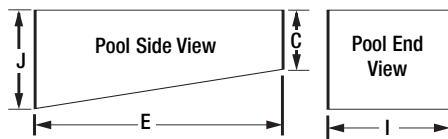

D. Safety Ledge Hopper

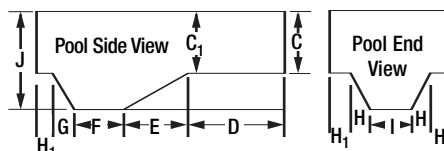

Fill in all measurements that apply to your hopper type:

C _____ ft _____ in

C₁ _____ ft _____ in

D _____ ft _____ in

E _____ ft _____ in

F _____ ft _____ in

G _____ ft _____ in

H _____ ft _____ in

H₁ _____ ft _____ in

I _____ ft _____ in

J _____ ft _____ in

Are you measuring the bottom of your pool correctly?

Be sure you are **NOT** measuring the slopes when taking horizontal bottom measurements. We only use measurements parallel to the deck. See the diagrams below for the correct way to measure a coved bottom.

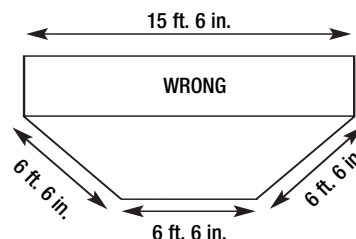
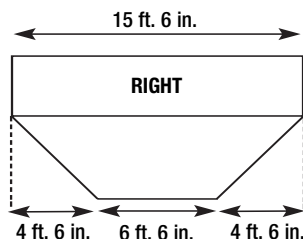

POOL SHAPE

Check one & fill in the measurements below:

NOTE: Diagonal measurements must be taken to imaginary squared off corners of your pool if you have radius or cutoff corners. (i.e. diagonal measurement Q & R on the rectangular pool)

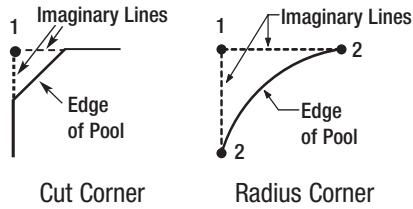

Measure to imaginary point 1, NOT the edge of the pool

Dimensions: Please transfer all of the measurements you have taken into the appropriate spaces below. NOTE: you may not use all the letters below, depending on your pool shape.

Rectangular

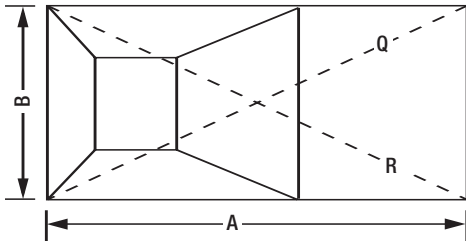

- | | |
|----------------------------------|---------------------|
| A _____ ft _____ in | M _____ ft _____ in |
| A ₁ _____ ft _____ in | N _____ ft _____ in |
| A ₂ _____ ft _____ in | O _____ ft _____ in |
| B _____ ft _____ in | P _____ ft _____ in |
| B ₁ _____ ft _____ in | Q _____ ft _____ in |
| B ₂ _____ ft _____ in | R _____ ft _____ in |
| K _____ ft _____ in | W _____ ft _____ in |
| L _____ ft _____ in | X _____ ft _____ in |

True "L" Left

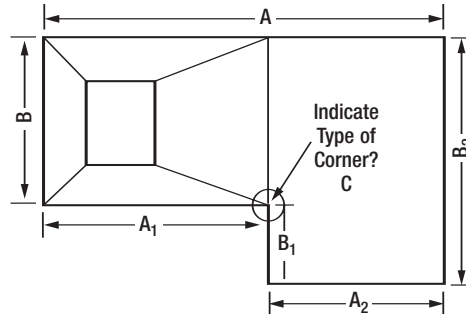

C (Corner Type) Applies to True "L" Left & Right ONLY:

Cut Corner

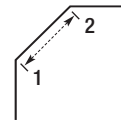

Point 1 to Point 2: _____

90 Degree Corner



No measurements required for square corners.

Radius/Rounded Corner

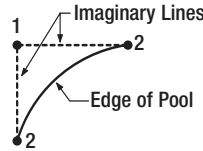

Point 1 to Point 2: _____

True "L" Right

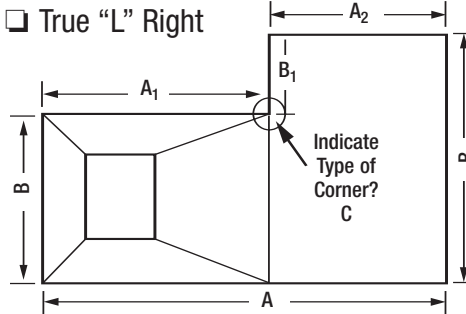

Contour Bottom Grecian

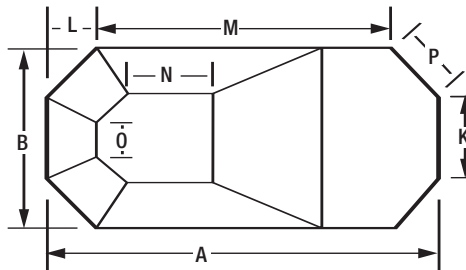

Square Bottom Grecian

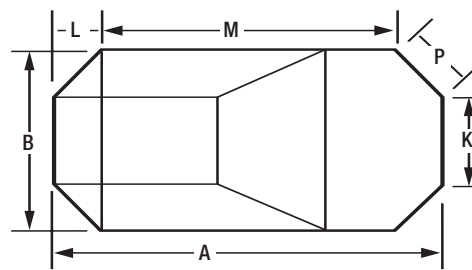

Oval with Parallel Sides

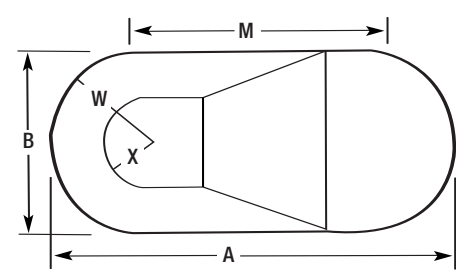

VINYL COVERED STEPS

Please check one:

- Fiberglass (No Further Measurements Needed)
- Vinyl Covered (Fill Out the Section on Pg. 3)
- No Steps

What is the Step Position?

Please circle the position that best describes the location of your step and provide measurements (Y) and (A).

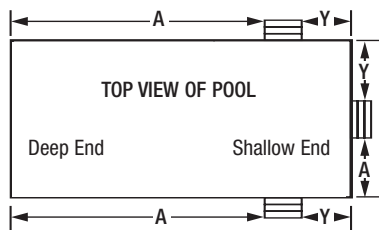

Record Measurements
(Y) & (A) below:

Y = _____ ft _____ in
 A = _____ ft _____ in

Top Step Corners

- Square
- Radius _____ in
- Diagonal _____ in

- Rod Pockets** Yes No
 Size _____
 (Diameter of Rod)

- Step Setback** Yes No
 If yes, see below
 Setback width (K) _____ in
 Straight Angled (L) _____ in

	A	
	B	
*	C	
**	D	
**	E	
**	F	
***	G	
***	H	
***	I	
***	J	
	K	
	L	

IMPORTANT: * C must equal wall height of shallow end
**** D+E+F Must equal B**
***** G+H+I+J Must equal C**

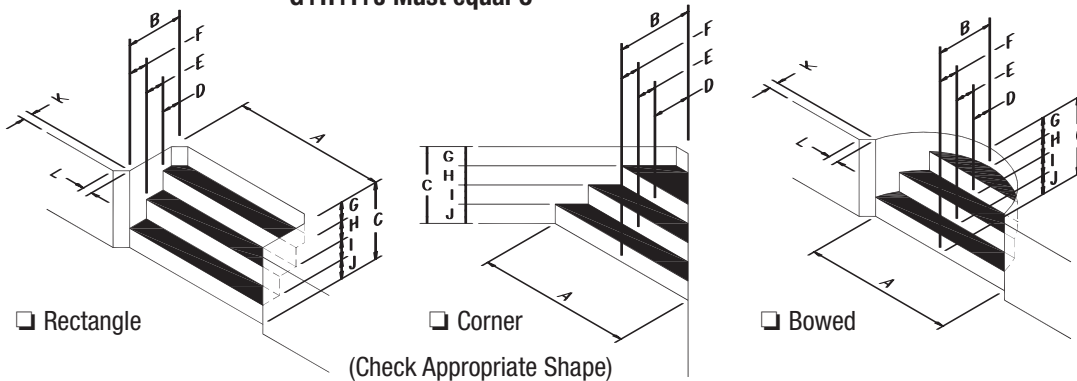

HELPFUL HINTS

Measuring the pool bottom without entering the pool:

You will be able to make horizontal measurements of you pool bottom without entering the pool. Taking these measurements is easier than you may think, when you use this easy-to-make measuring tool.

You will need:

1. A long straight pole (telepole) – “fishing pole”
2. String attached to one end of the pole
3. Some sort of weight tied to the other end of the string
4. A measuring tape

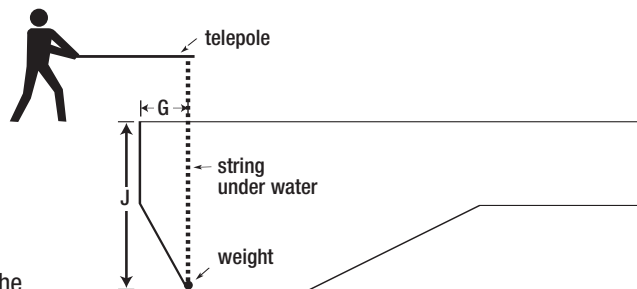

Follow the instructions below, using your fishing pole, to make these measurements.

Horizontal Bottom Measurements: Use your “fishing pole” to “fish” for a point on the bottom of the pool. With the pole to the ends of the pool and the string vertical (allow no slack in the string), measure the distance from the edge of the pool (water’s edge) to the end of the pole where string is attached. You should “fish” for points that will achieve the desired measurements based on the bottom contour of your pool (pictured on page 1).

For example, to take measurement (H), you would stand on one side of the pool, and “fish” for a corner of the Hopper. You would then measure the distance from the edge of the pool (water’s edge) to the end of the pole where the string is attached.

Depth measurements: When taking the depth measurements (C) and (J), be sure to measure from the bottom of the pool floor to the bead receiver (for beaded liners) OR to the board where the liner is nailed or stapled (for overlap liners). Do **not** measure to the top of the pool if you have a bead receiver, your measurement will be incorrect.